

ASSEMBLY INSTRUCTIONS

BUOT0129 DINING TABLE

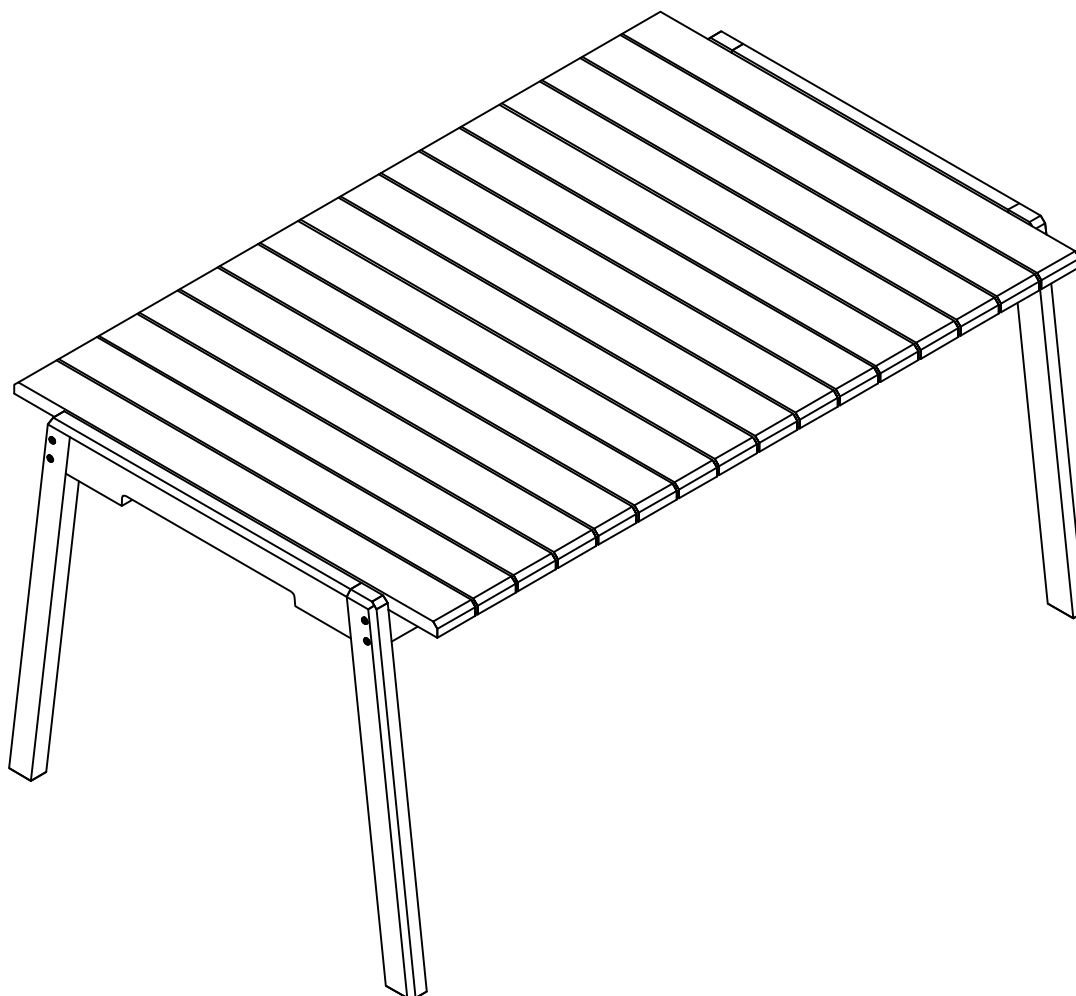

REPLACEMENT PARTS

Please do not contact the company purchased from as we can help you faster.
Order replacement parts and hardware at “www.boltonfurniture.com”

Tools Required (Not Included)

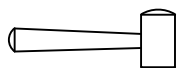

Rubber Hammer



Phillips Screwdriver

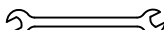

Wrench



Cordless Drive (*)

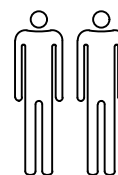

(*) NOTE: Optional - use in place of hex drive.

Identifying the Hardware-Identify the hardware using the illustrations below.

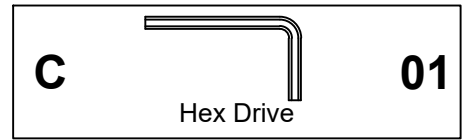
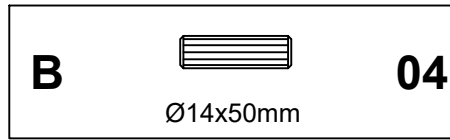
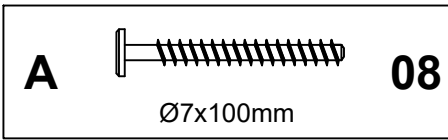

01

